

Remote Lesson #32

Theme: Transportation - Trucks
Storytime: Trucks
Reader: Mrs. Steele
Learning Corner: Patterns, Letters & Numbers
Parent Corner: CGS Catechesis of the Good Shepherd

Trucks

Storytime: Trucks by Byron Barton
<https://youtu.be/HDmPkeuVfJ0>



Monster Truck information, games, videos, etc. can be found on Hot Wheels website
<https://hotwheelsmonstertruckslive.com/>

Get ideas for how to set up your own track and race with
Monster Trucks Race Through a Snowball Avalanche
https://youtu.be/vR_z72JKpoY

Literacy Video:

Pinellas Suncoast Firefighters share a story and a peek at some of the many awesome vehicles that help them do their important work.

https://photos.google.com/photo/AF1QipN_iglfEpSjMOWI1VjfnonKL_JRpwBhEo7i6tEK

Fire Truck - Gecko's Real Vehicles

<https://youtu.be/KjyLrBiQ9lw>

Remembering when...



we had our own monster truck visit this school year! In this picture, Room 3 poses with Mr. and Mrs. Cole and their really BIG truck.

Activities for Toddlers:

Learn To Count 1 to 10 with Big Trucks | Gecko's Garage

<https://youtu.be/BtWNC3yaDuU>

Best Toddler Learning Cars Trucks Colors for Kids #1 Teaching Children Colours Tayo the Little Bus

<https://youtu.be/wl-hWmpvTXA>

Coloring:

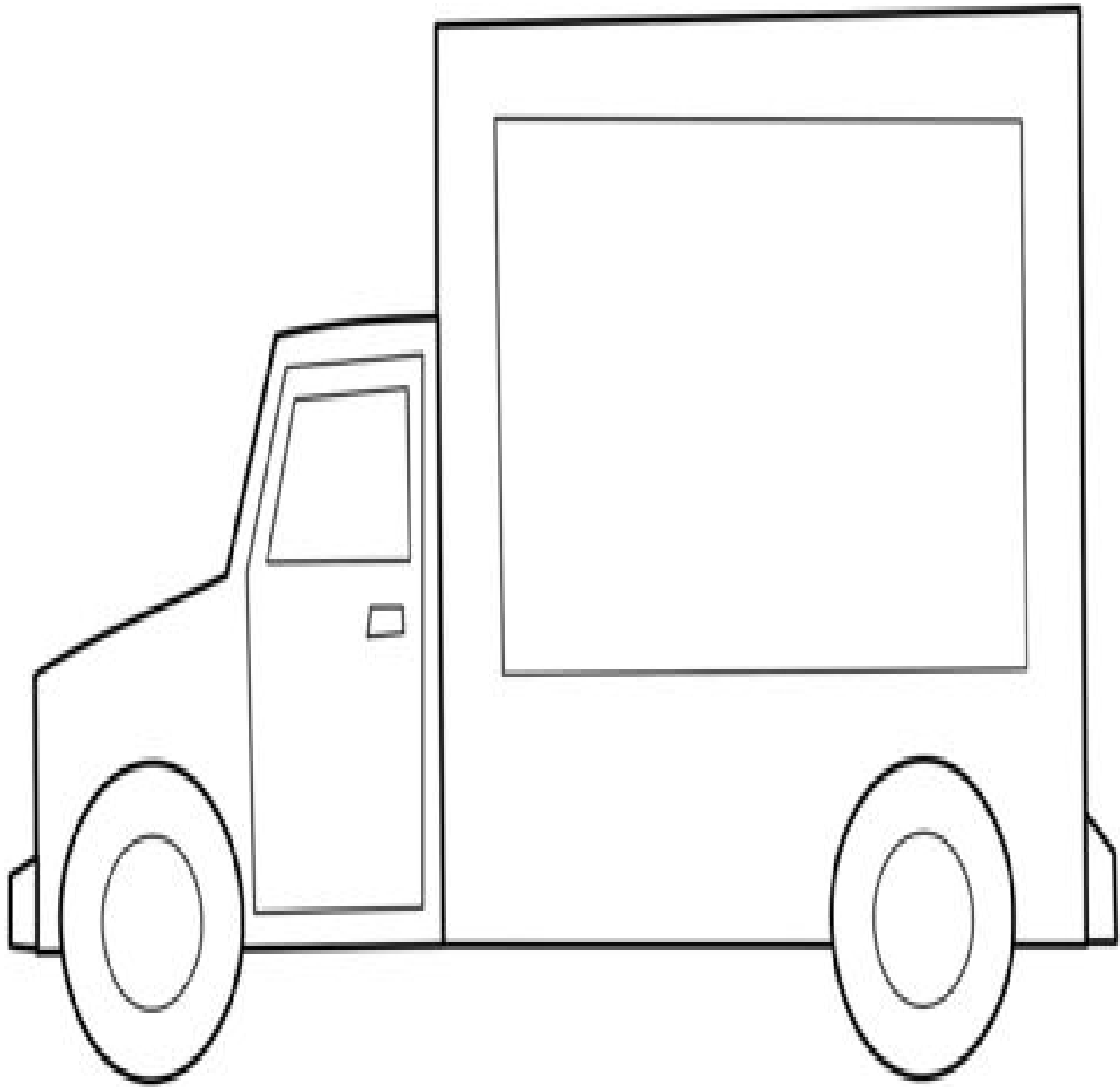

Activities for Preschoolers:

Trucks for Kids | Learn Truck Names, Sounds, & Colors | Fun & Educational Organic Learning
<https://youtu.be/QQTfGEX2Bek>

Tracing: Capital Letters, Numbers and Shapes
<https://www.worksheetfun.com/letter%20and%20numbers/lettersandnumbersworksheetfuntracing3.pdf>

Tracing: Lowercase Letters
https://www.worksheetfun.com/wp-content/uploads/2013/09/Tracing_small_letters_cars_1.pdf

Cut and Paste: Patterns (pictures)
https://www.worksheetfun.com/wp-content/uploads/2020/06/wfun20_pattern_picture_cut_paste_T1_7.pdf

Cut and Paste: Patterns (shapes)
https://www.worksheetfun.com/wp-content/uploads/2020/06/wfun20_pattern_shape_cut_paste_T1_6.pdf

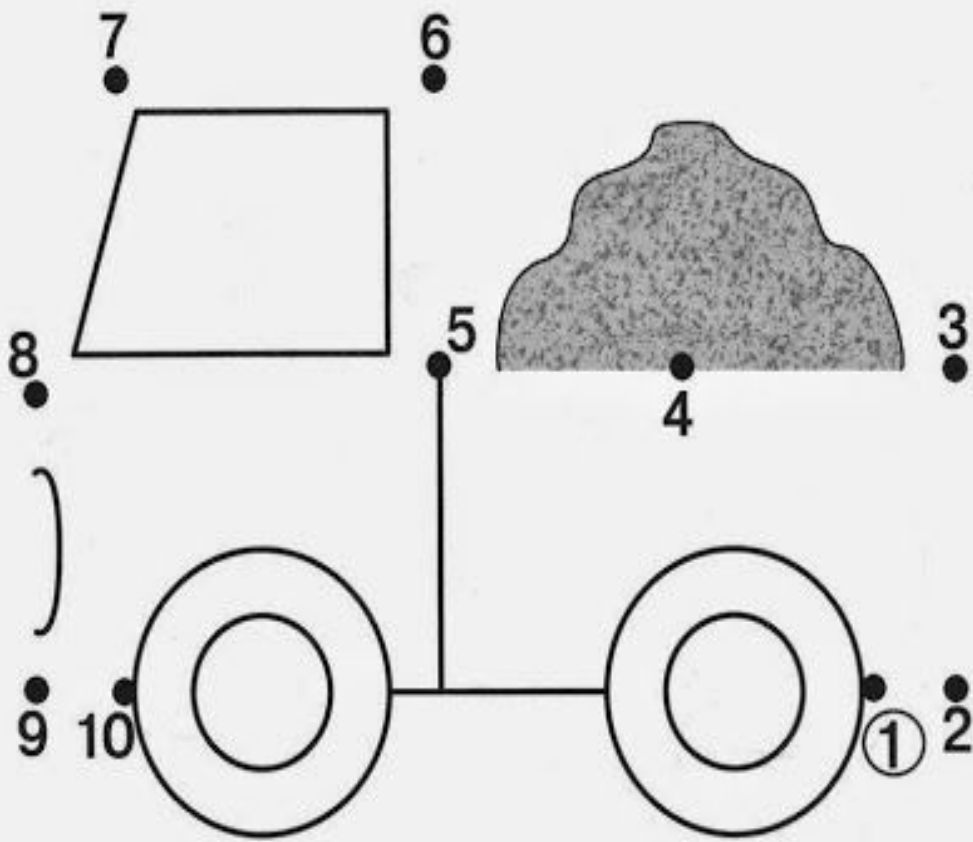

Name: _____

Write the number that comes after.

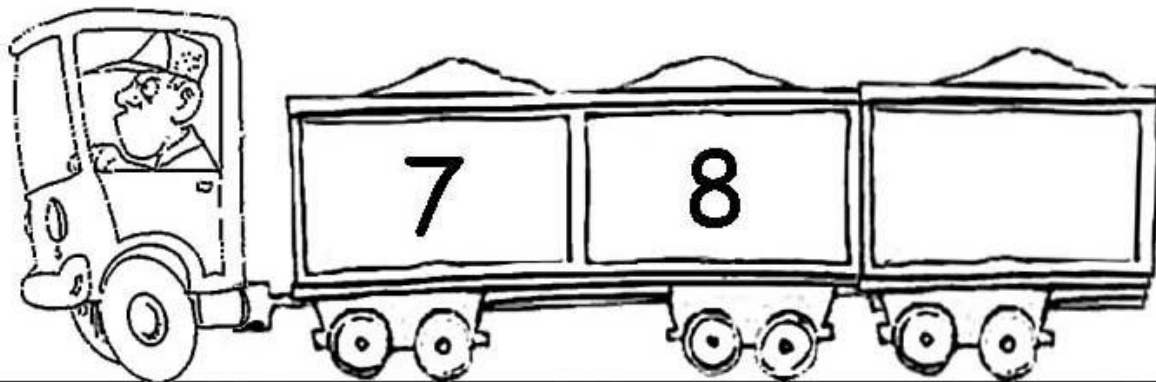
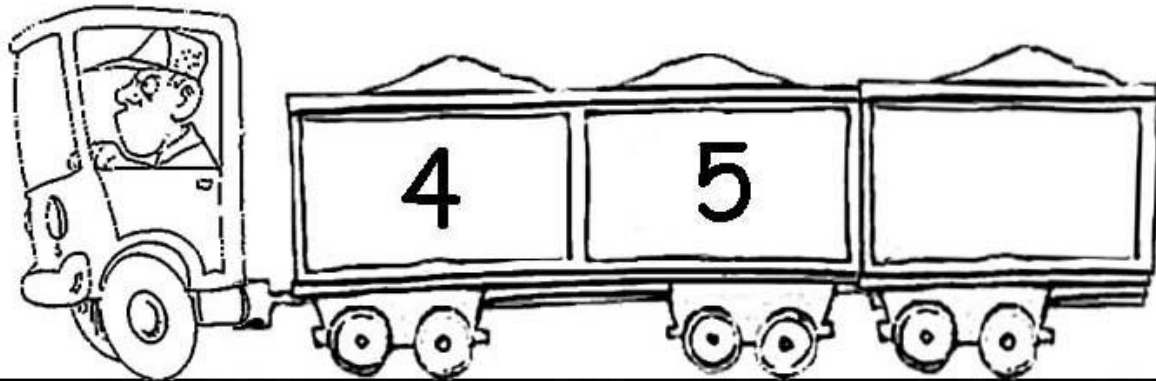
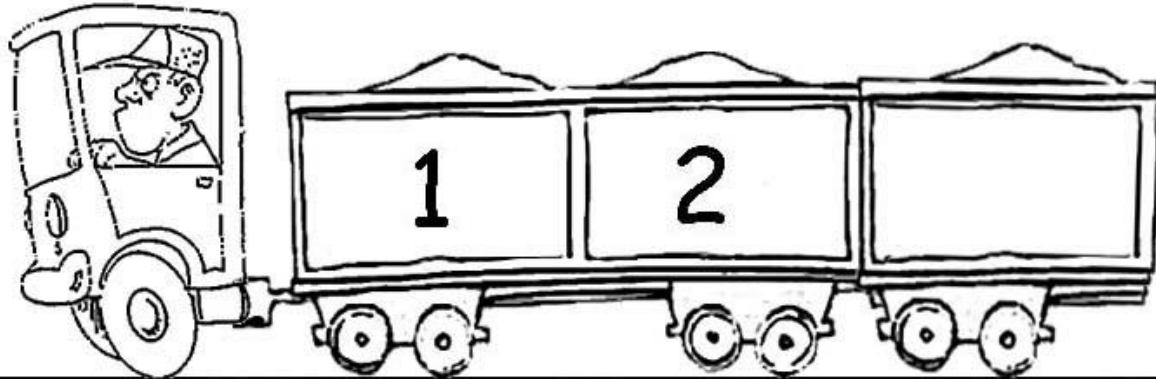



Fire Truck Letter Find

Name: _____

Directions: Find the letters. Color them the correct color. Color the picture.

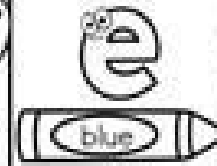
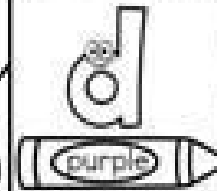
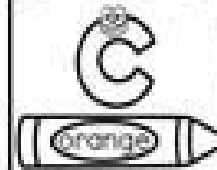
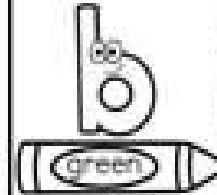
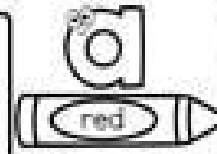

Crane truck



More truck images to color:

<http://www.supercoloring.com/coloring-pages/transport/trucks>

Parent Corner

St. Jerome Church offers faith formation for children of all ages. They utilize a method of teaching known as the Montessori approach. Our center fully supports this type of hands-on learning. We incorporate these methods into our classroom lessons. Our students also have the benefit of visiting the beautiful atriums established by our faith formation program. I hope you'll look into the CGS program philosophy and consider registering your child for the program offered at St. Jerome Church.

The Catechesis of the Good Shepherd especially honors the spiritual values of childhood and wishes to nurture the formation of a consciousness which is oriented to the construction of the history of salvation in justice and solidarity.

The Characteristics of the Catechesis of the Good Shepherd, #28

<https://www.cgsusa.org/discover/>

Catechesis of the Good Shepherd

<https://youtu.be/Zn5rFxlUsQY>